

PORODO
LIFESTYLE



Porodo Lifestyle

Clearweave 2-in-1 Lint Remover

SKU: PDLFSTJS31WH

Table of Contents

Product Overview	2
Specifications	2
Schematic View	3
Included Accessories	3
Operating Instructions	4
Charging Guidelines	6
Safety Precautions	7
Cleaning & Maintenance	9
Troubleshooting	11
Disposal	11
Warranty	12
Contact Us	12

Product Overview

The Porodo Clearweave 2-in-1 Lint Remover is a rechargeable device designed to remove lint and fuzz from fabrics, providing a clean and static-free finish. It features a 33ml transparent lint container for easy viewing and emptying. The device has a controlling switch and an ergonomic handle for comfortable use. With dual-speed levels, it offers flexibility for different fabrics. The blade safety protection ensures safe operation, and it provides up to 90 minutes of working time on a full charge, making it ideal for keeping clothes and fabrics looking fresh.

Specifications

Material	ABS + 420J2 Stainless Steel
Battery Capacity	600mAh
Rated Power	3W
Working Time	1.5 hours
Charging Time	1 hour
Motor Speed	6500rpm, 7500rpm
Noise Level	≤75dB
Lint Bin Capacity	33mL
Net Diameter	0.35mm, 52mm
Cable Included	30cm USB-C Cable
Operating Temperature	-5°C to -45°C

Water Resistance Level	IPX5
Product Weight	178g
Product Size	74 x 75 x 200mm
Model Number	PDLFSTJS31

Schematic View

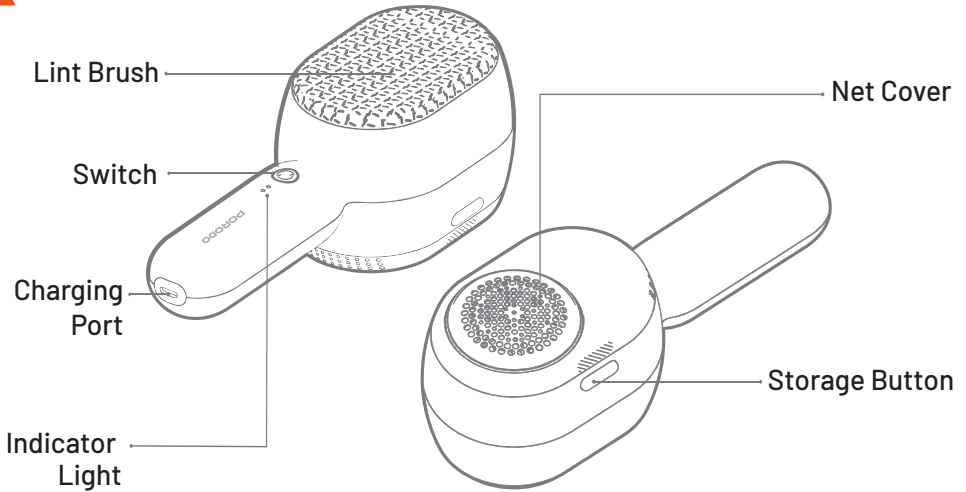

Included Accessories

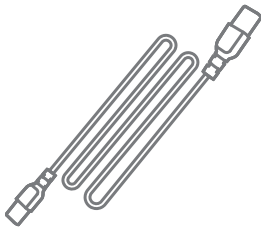

a. Charging Cable ×1

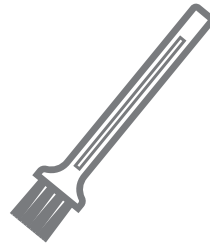

b. Lint Brush ×1

Operating Instructions

a. Operating Instructions for Lint Removal

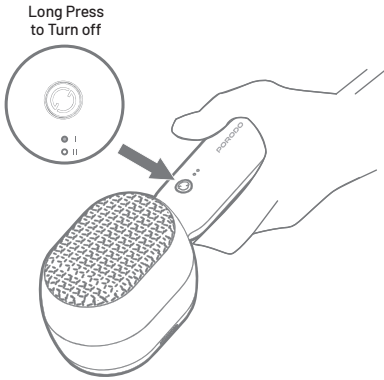

1. Press the () button to turn on the device and begin removing lint from your clothes.

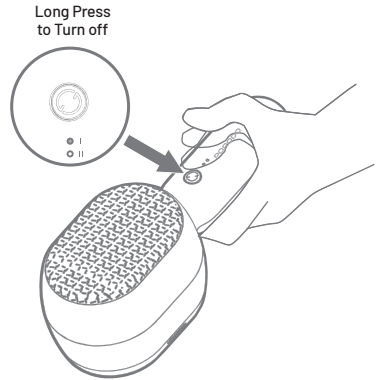

2. The default setting is Gear 1 when the device is turned on. Press the button again to switch to Gear 2. To turn off the device, press and hold the button for 1 second.



3. Gear 1 is indicated by one white light, and Gear 2 is indicated by two white lights. Gear 2 also supports plug-and-play functionality.

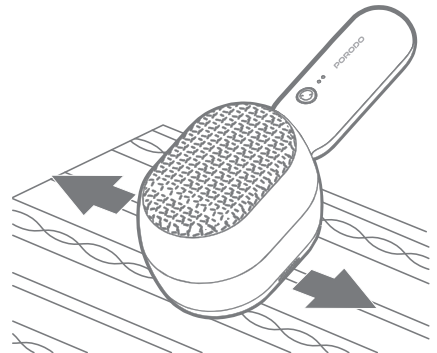

4. For knitted fabrics, slide the device along the direction of the pattern.

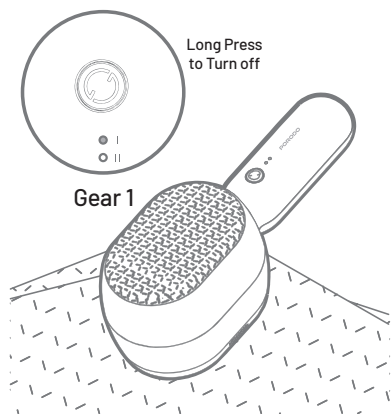

5. For thin fabrics, use Gear 1 and fold the clothes into two layers on a flat surface before trimming.

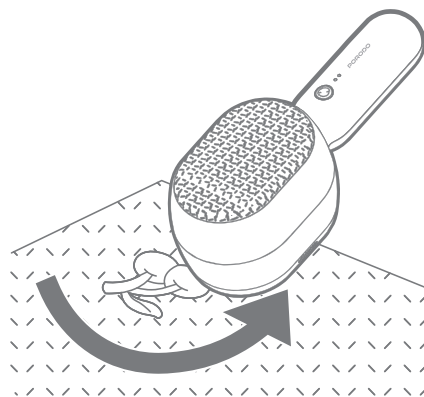

6. If the clothing has protruding decorations, avoid these areas while trimming.

b. Operating Instructions for Lint Brush

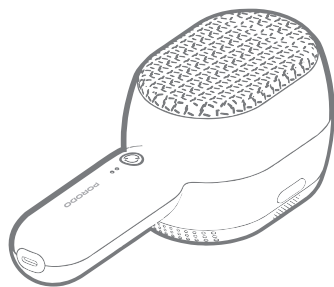

1. The lint brush on the back is designed to remove dust and hair from clothes.

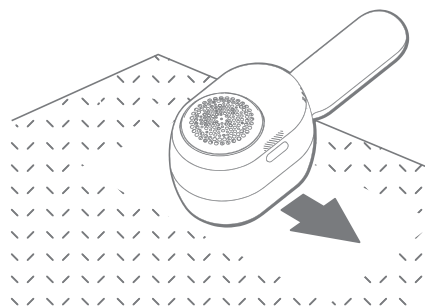

2. To use the lint brush, gently move it in the opposite direction of the fabric's texture, in one direction only. Avoid brushing back and forth to prevent damage to the fabric.

Charging Guidelines

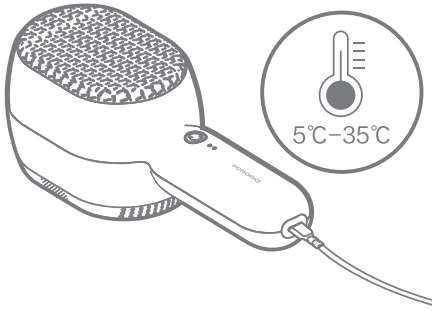

1. Place the product in an environment with a temperature between 5°C and 35°C for charging.



2. Take the included charging cable, insert one end into the charging port located at the bottom of the product's handle, and connect the other end to a 5V charger.



3. During charging, the white indicator light in Gear 1 will flash. Charging will take about 60 minutes, and once fully charged, the product can be used for about 60 minutes (in Gear 2).



4. After charging is complete, the white indicator light in Gear 1 will stay on and turn off once the power is disconnected.

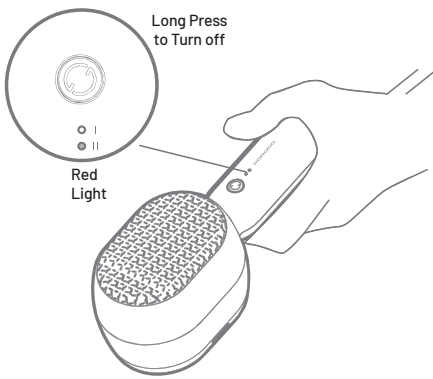

5. During use (in Gear 1 or Gear 2), when the battery level falls below 20 % , the second indicator light will turn red, and the light will pulse, indicating that the battery is low and needs to be charged.

Warning

- 1.** Do not use a charger with a voltage higher than DC 5V to charge this product, as it may damage the device.
- 2.** To ensure the product's lifespan, disconnect the power once the device is fully charged.
- 3.** Before discarding the device, the battery must be removed.
- 4.** Make sure the device is powered off before removing the battery.
- 5.** To remove the battery: First, unscrew the back cover and open it. Then, remove the battery compartment cover, and finally, take out the circuit board assembly and cut off the battery.

Safety Precautions

To ensure safety, this product complies with all applicable standards and regulations (low voltage, electromagnetic compatibility, environmental directives, etc.).

- 1.** This product is not suitable for use by individuals who are physically, sensorially, or mentally impaired (including children) or those who lack experience or knowledge, unless they are supervised by someone responsible for their safety or have received prior guidance on how to use the product. Always supervise children to ensure they do not treat the product as a toy.
- 2.** This product is suitable for children aged eight and older, or individuals who lack relevant experience and knowledge, provided they have been trained or guided to understand how to safely use the product and are aware of the potential hazards. Children should not use this product for play.

- 3.** Children under the age of 8 should not be responsible for cleaning or maintaining the product, but children aged 8 and older may do so under adult supervision.
- 4.** Keep this product and its power cord out of reach of children under the age of 8.
- 5.** The product's weight may vary due to factors such as shipping, external environment (temperature, humidity), etc.
- 6.** If the product falls or shows visible signs of damage, it should not be used. To avoid danger, do not attempt to disassemble the product. If there are any issues, take it to an authorized service center for inspection.
- 7.** If the product is damaged, it must be replaced by the manufacturer, its service department, or similar qualified professionals to avoid danger.
- 8.** This product is for home and domestic use only. The manufacturer is not responsible for any issues resulting from improper use or failure to follow the user manual, and the warranty will be void.
- 9.** For your safety, this product has been tested by national authorities and complies with national standards and legal regulations.
- 10.** Keep the product's power cord away from sharp objects and heat sources.
- 11.** Do not use non-authorized accessories, as they may cause fire, electric shock, or personal injury.
- 12.** Never use this product for any purpose other than removing lint from clothing.
- 13.** Before use, make sure to lay the clothing flat to avoid wrinkles, as wrinkles may cause damage to the fabric during trimming.
- 14.** Do not press the lint remover too hard while using it, as excessive pressure may damage the fabric.
- 15.** Do not use this product on clothes that are being worn, as it may cause injury to the body or damage to the clothing.
- 16.** Do not use this product to trim lint from stockings or satin fabrics, as they may get sucked into the blade and get damaged.
- 17.** Do not charge this product for more than 12 hours continuously.
- 18.** Never leave the product unattended while it is charging.
- 19.** Do not remove the net cover unless it needs to be cleaned.
- 20.** Do not press on the net cover during use.

21. Before discarding the device, the battery must be removed from the device.
22. Ensure the device is powered off before removing the battery.
23. Warning: Keep the device dry.
24. Repair: Repairs must be performed by professionals using original parts. Attempting to repair the product yourself may pose a danger and will void the warranty.
25. Electromagnetic Fields (EMF): This product complies with relevant electromagnetic field (EMF) standards. Based on current scientific evidence, if used correctly and operated according to the instructions in this user manual, this product is safe.

Cleaning & Maintenance

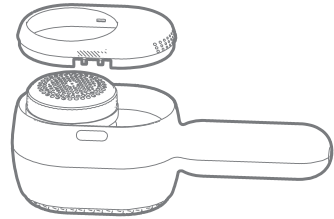
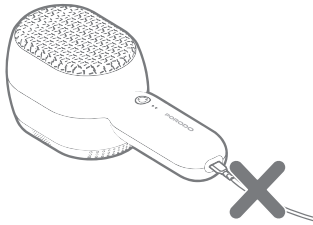

1. Ensure the product is turned off and not connected to the charging cable (never turn on the product while cleaning).
2. Press the button on the left side of the device to remove the lint compartment.

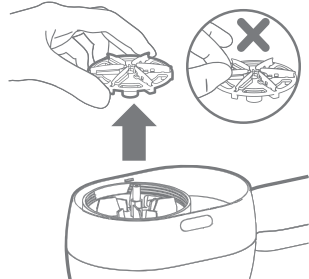
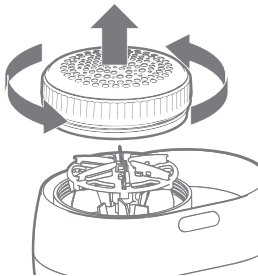

3. Rotate the net cover counterclockwise to remove it.
4. Gently pinch the edges of the blade and lift it off. Never pinch the sharp edges of the blade to avoid injury.

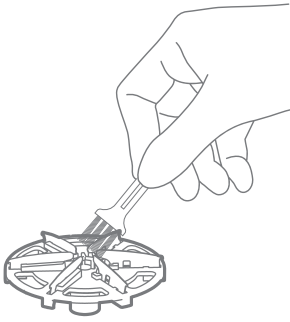

5. Use the included brush to clean the blade thoroughly.

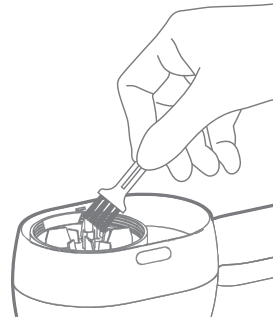

6. After cleaning the blade, also clean the lint compartment.

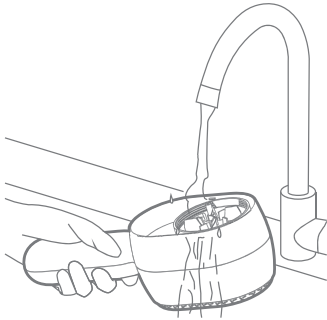

7. Rinse the head of the machine under a tap and let it air dry.

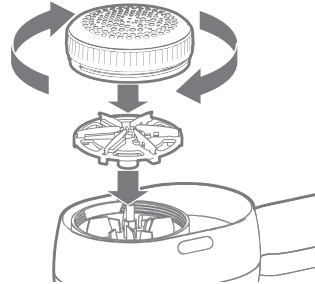

8. Place the blade back into the lint compartment and rotate the net cover clockwise to secure it.

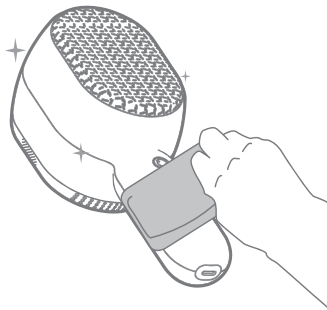

9. Clean the product with a damp cloth or a non-abrasive sponge. Do not use soap or cleaning agents.

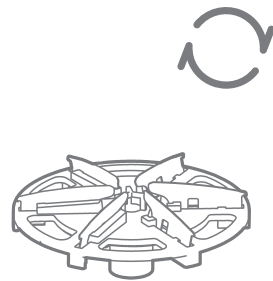

10. To maintain the best lint removal performance, it is recommended to replace the blade once a year.

Troubleshooting

Issue	Possible Causes	Solution
Cannot remove lint	Lint buildup inside the product	Clean the product
Lights are on, but the device is not working	Net cover not screwed on properly	Check and ensure the net cover is properly screwed on
Blade is not rotating	Battery is drained	Charge the product
Device cannot charge	Charging port is not plugged in properly	Ensure the charging port is properly connected
White light flashes and then turns off	Excessive lint buildup inside the net cover causing protection mode	Clean the lint and restart the product

Disposal

This product must not be disposed of as unsorted household waste. It is important to separate such waste for proper treatment and recycling, in compliance with local waste management regulations.



Warranty

Products that you buy directly from our **Porodo** website or shop come with a 24-month warranty.

When you buy **Porodo** products from any of our approved sellers, you only get a 12-month warranty. If you want to extend this warranty, go to our website at <https://www.porodo.net/warranty> and fill out the form with your information. Don't forget to upload a picture of the product too. After we've checked and accepted your request, we'll send you an email to confirm that your product's warranty has been extended.

For more info, please check:
<https://www.porodo.net/warranty>

Contact Us

If you have any questions about this Privacy Policy, please contact us at:

info@porodo.net

Website: <https://www.porodo.net/>

Service Support: support@porodo.net

Instagram: **porodo**