

PORODO



Porodo

**Audix Elite 3 In 1 Lavalier Microphone
Type-C, Lightning and 3.5mm Aux**

SKU: PDLAMPHF13BK

Table of Contents

Specifications	2
Product Overview	2
Package Contents	3
Schematic View	3
Lightning/Type-C Receiver Usage Guide	4
3.5mm Receiver Usage Guide	5
LED Indicator Guide	6
Safety Precautions	8
Disposal	9
Warranty	9
Contact Us	9

Specifications

Battery	40mAh (Microphone), 100mAh (Receiver)
Input	5V/2A, 10W
Working Voltage	Lithium Battery 3.7V
Working Current	<15mA
Charging Time	1.5 Hours
Working Time	Up to 3 Hours
Transmission Distance	15m-20m
Model Number	PDLAMPHF13

Product Overview

The Porodo Audix Elite 3-in-1 Lavalier Microphone is an innovative and versatile audio solution designed for content creators, professionals, and anyone in need of high-quality sound on the go. With support for Type-C, Lightning, and 3.5mm Aux connections, this microphone is compatible with a wide range of devices, including smartphones, tablets, and cameras, ensuring flexibility across various platforms. It features low latency for real-time audio capture, making it perfect for live streaming, podcasting, or recording on the move with minimal delay. The instant wireless setup and auto-pairing technology make it incredibly easy to use—simply plug it in, and you're ready to go. There's no need for complicated software or drivers, thanks to its plug-and-play functionality. The microphone offers up to 3 hours of working time, providing long-lasting performance for extended recording sessions or events.

Additionally, it delivers crystal clear audio that ensures your voice or sound is captured with exceptional clarity, whether you're recording a video, delivering a presentation, or streaming online. The Porodo Audix Elite is the ideal microphone for those who demand professional-grade sound in a portable, user-friendly package. The product consists of two parts, a microphone transmitter and a 3-in-1 multi-function receiver:

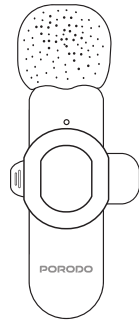

Microphone Transmitter

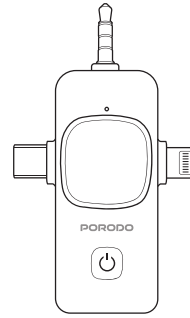

3-in-1 Multi-function Receiver

Package Contents

- Microphone transmitter
- 3-in-1 multi-function receiver
- Type-C charging cable
- Storage bag
- 3.5mm single-wired earphones

Schematic View

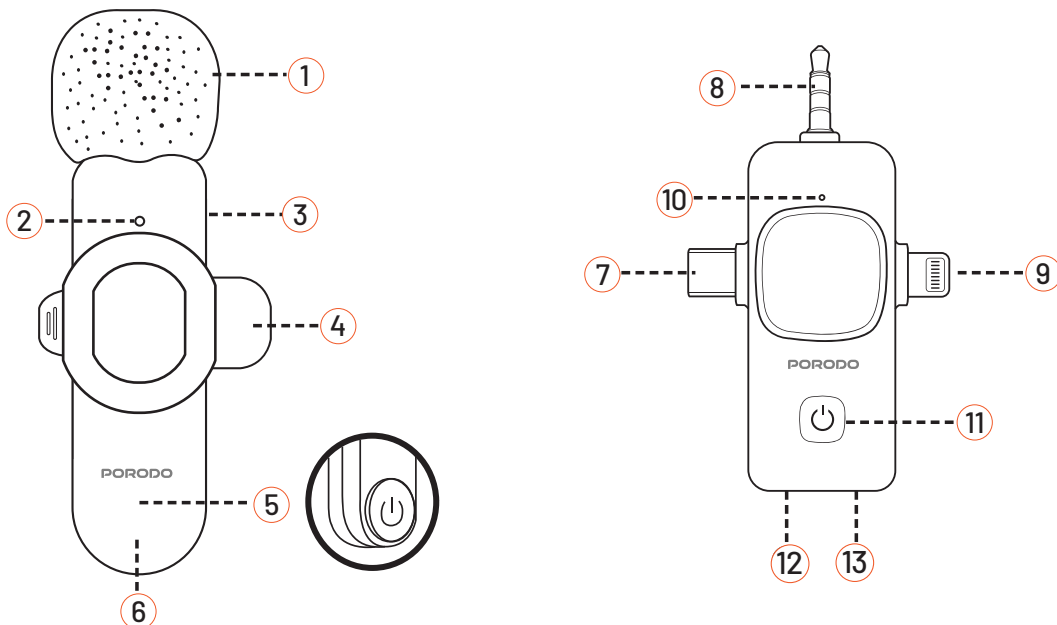

1. Microphone Cover
2. Microphone Status Indicator
3. Microphone Charging Port (Type-C)
4. Microphone Clip
5. Microphone Power Button
6. Microphone Reset Button
7. Receiver (Type-C)
8. Audio Receiver (3.5mm)
9. Lightning Audio Receiver
10. Receiver Status Indicator
11. Receiver Power Button
12. Receiver Charging Port (Type-C)
13. Audio Output(3.5mm)

Lightning/Type-C Receiver Usage Guide

1. Connect the Lightning or Type-C receiver to the corresponding port on your mobile device (either the Lightning or Type-C port). Once connected, the receiver's green light will flash quickly, indicating it is successfully powered on and ready for use.



2. Press the power button on the microphone once. The device is successfully powered on when the green light appears.

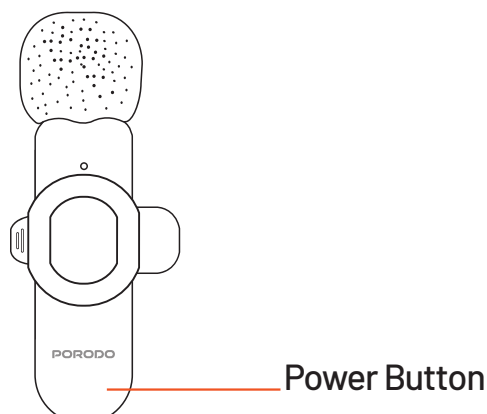

- The green light on the receiver remains on, indicating that the microphone is activated when you open the phone's camera for video recording or launch live streaming apps to broadcast a live show.

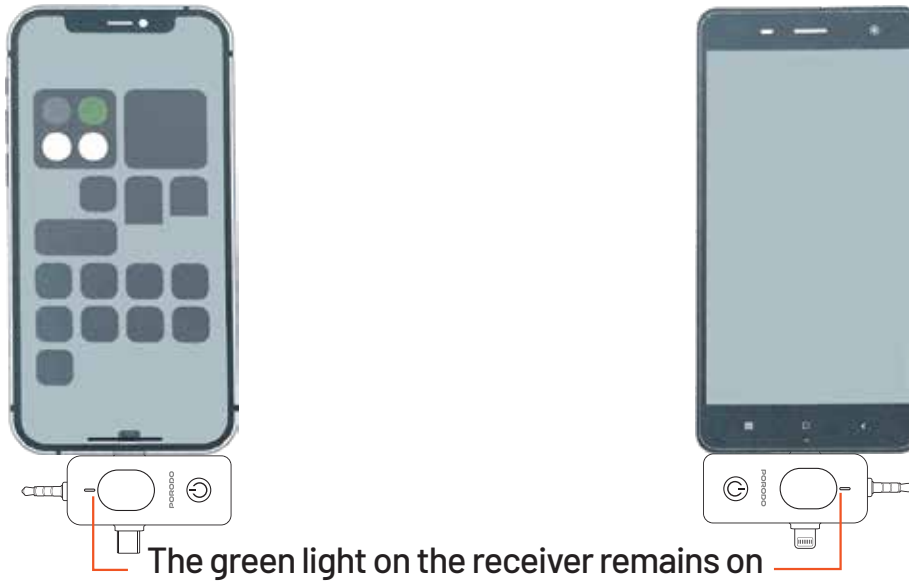

- If the mobile phone is low on battery during live streaming, the external power supply will automatically charge the mobile phone through the Type-C port of the receiver.

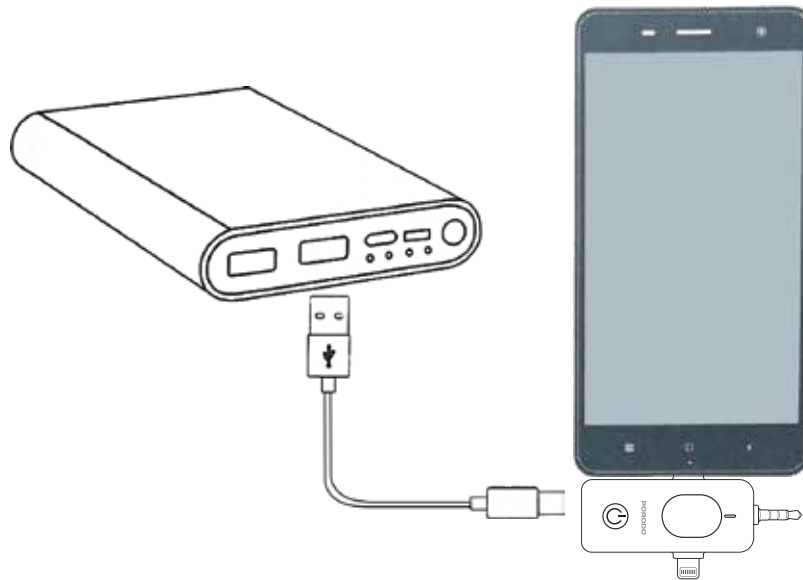

3.5mm Receiver Usage Guide

- Insert the 3.5mm receiver into the 3.5mm port of your device. Once connected, the green indicator light will remain illuminated, confirming that the receiver is properly powered and ready for use.

the green indicator light remains on

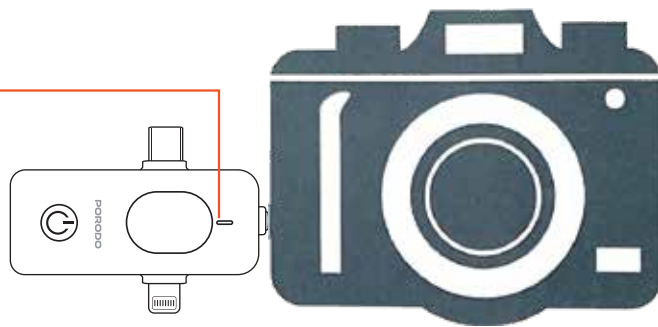

2. Press the power button on both the microphone and the receiver. The device is successfully powered on when the green light appears.

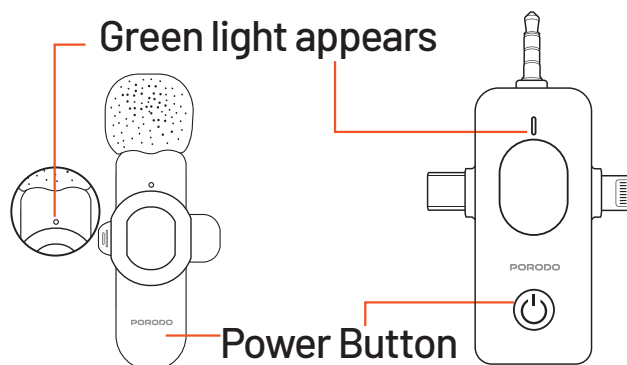

3. Power on the device, and the microphone will activate automatically, ready to use.

LED Indicator Guide

A. Microphone Transmitter

Functions	Usage Guide	Light Status
Power On	Single-Press to power button function	Green light on
Power Off	Press and hold the power button (3-4s) / Auto power off after 10 mins of no Connection	Green light off
Charging	Charging via Type-C Cable	Red light on while charging, and light off once fully charged
Search for Pairing	-	Green light flashes slowly
Paired	-	Green light always on
Low Battery Warning	Battery Below 20 %	Blue light flashes slowly
Reset	Press and hold the reset key (3s)	-
Stop	Press Once	Blue light is always on
Unpair Devices	Double-press the reset key quickly	Green light flashes quickly

B. Lightning Receiver

Functions	Usage Guide	Light Status/Prompt tone
Power on	Plug into the device	Green light flashes
Power off	Plug off the device	Light off
Searching for pairing	-	Green light flashes slowly
Paired	-	Green light on
Unpair Devices	Triple-press the power button quickly within 10s after powering on	Green light flashes quickly
Monitor volume up and down, loop control	Double-press the power button	One beep: minimum volume, Two beeps: medium volume, Three beeps: maximum volume

C. 3.5mm Receiver

Functions	Usage Guide	Light Status/Prompt tone
Power on	Single-touch power button	Green light flashes
Power off	Press and hold the power button for 3s	Light Off
Searching for pairing	-	Green light flashes slowly
Paired	-	Green light on
Low battery	The battery is in low power mode	Red light flashes
Unpair Devices	Triple-press the power button quickly within 10s after powering on	Green light flashes quickly
Monitor volume up and down, loop control	Double-press the power button	One beep: minimum volume, Two beeps: medium volume, Three beeps: maximum volume

D. Type-C Receiver

Functions	Usage Guide	Light Status/Prompt tone
Power on	Plug into the device	Green light flashes
Power off	Plug off the device	Light off
Searching for pairing	-	Green light flashes slowly
Paired	-	Green light on

Unpair Devices	Triple-press the power button quickly within 10s after powering on	Green light flashes quickly
Monitor volume up and down, loop control	Double-press the power button	One beep: minimum volume, Two beeps: medium volume, Three beeps: maximum volume

Note: Ensure that the receiver is unplugged from the device before attempting to listen to the video or recording. The audio will only be accessible once the receiver is disconnected.

Safety Precautions

1. Keep the microphone dry and away from moisture or liquid spills. Moisture can damage the microphone and affect performance.
2. Keep the volume at a safe level during use to avoid hearing damage. Start with a lower volume and gradually increase it to your desired level.
3. Do not expose the microphone to high temperatures or direct sunlight for extended periods. Excessive heat can damage the internal components.
4. When using the microphone, ensure it is securely attached to clothing or other stable surfaces to avoid accidental falls or damage.
5. Always unplug the microphone from your device when it is not in use to prevent unnecessary wear and conserve battery life.
6. Store the microphone in a cool, dry place, and use the provided carrying case if available to prevent tangling or damage to the cable.
7. Keep the microphone away from strong magnetic fields, as this can interfere with its functionality and performance.
8. This product is not intended for children. Keep the microphone and all its components out of the reach of children to prevent choking hazards or accidental damage to the device.
9. Never attempt to disassemble, puncture with sharp tools, repair, or modify the microphone. Tampering with the device may result in electrical hazards, malfunction, or permanent damage. Always seek professional assistance for repairs

Disposal

This product must not be disposed of as unsorted household waste. It is important to separate such waste for proper treatment and recycling, in compliance with local waste management regulations.

Warranty

Products that you buy directly from our **Porodo** website or shop come with a 24-month warranty.

When you buy **Porodo** products from any of our approved sellers, you only get a 12-month warranty. If you want to extend this warranty, go to our website at **porodo.net/warranty** and fill out the form with your information. Don't forget to upload a picture of the product too. After we've checked and accepted your request, we'll send you an email to confirm that your product's warranty has been extended.

For more info, please check:
porodo.net/warranty

Contact Us

If you have any questions about this Privacy Policy, please contact us at:

info@porodo.net

Website: **porodo.net**

Service Support: **support@porodo.net**

Instagram: **porodo**