

PORODO



Porodo

Orion Lavalier Microphone Type-C & Lightning

SKU: PDLAMPHF75BK

Table of Contents

| | |
|-----------------------------|---|
| Specifications | 2 |
| Product Overview | 2 |
| Schematic View | 3 |
| Receiver Usage Instructions | 4 |
| Operation Guide | 6 |
| Package Contents | 7 |
| Safety Precautions | 7 |
| Disposal | 8 |
| Warranty | 9 |
| Contact Us | 9 |

Specifications

| | |
|------------------------|-----------------------------------|
| Battery Capacity | 650mAh (Case), 55mAh (Microphone) |
| Input | 5V/2A, 10W |
| Working Voltage | Lithium Battery 4.16V |
| Working Current | <14.2mA |
| Charging Time | 1 Hour |
| Working Time | 5 Hours |
| Transmission Distance | 15m-20m |
| Microphone Sensitivity | -38dB |
| Model Number | PDLAMPHF75 |

Product Overview

The Porodo Orion Lavalier Microphone with Type-C & Lightning connectors offers a seamless and high-quality audio recording experience for mobile devices. Featuring instant wireless setup and auto pairing technology, it allows for quick and effortless connection. The microphone delivers precise reverb

and crystal-clear audio, ensuring clear and distortion-free sound, making it ideal for content creators, podcasters, and presenters. With up to 5 hours of working time, it's perfect for long recording sessions. Its sleek design and advanced features make it a must-have for anyone looking to enhance their audio quality on the go. Its versatile design makes it ideal for a variety of uses, including online live broadcasts, video shooting, program production, interviews, recordings, video teaching, and other occasions that demand clear and reliable sound quality.

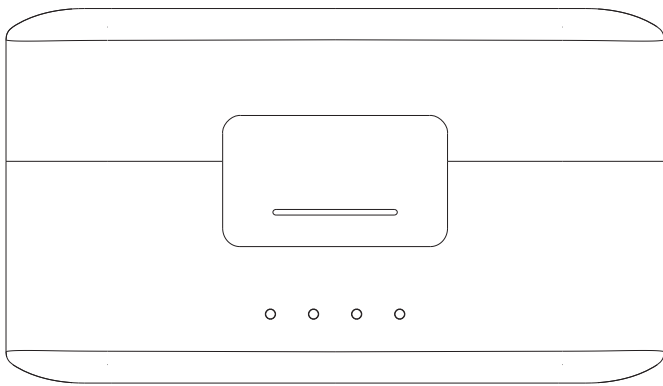

Charging Case

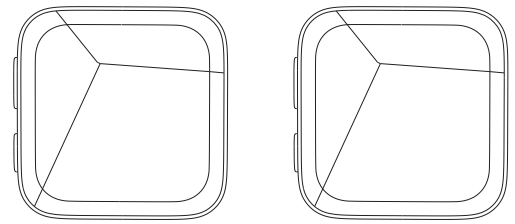

Microphone

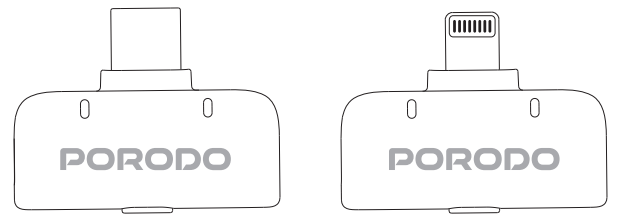

Receiver

Schematic View

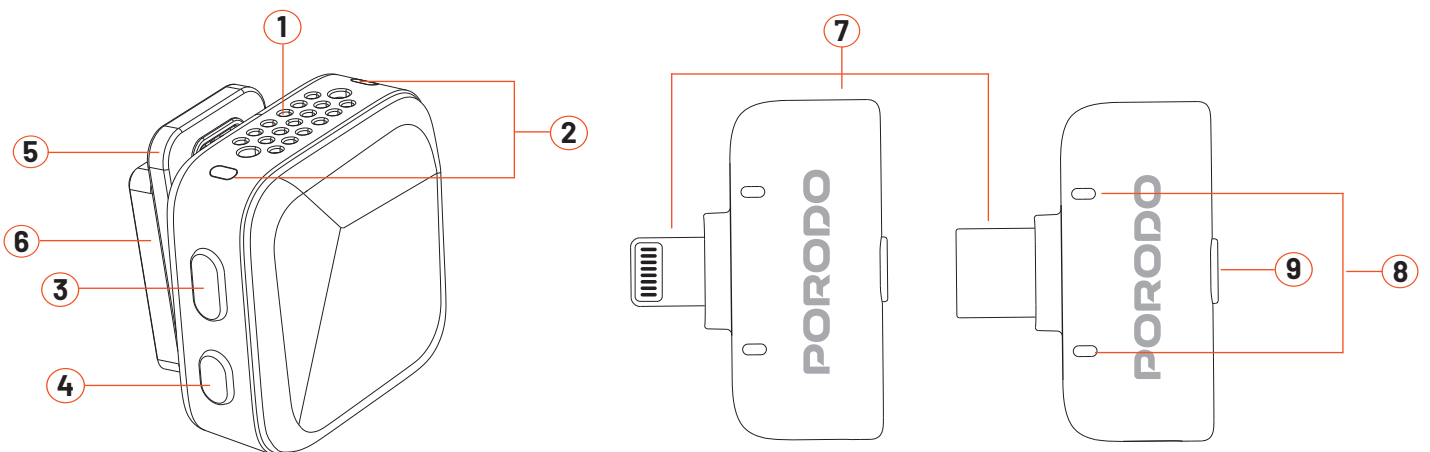

1. Microphone Audio Port
2. Microphone Indicator Light
3. Microphone Control Button
4. Microphone Power Button
5. Microphone Clip

6. Magnetic Plate
7. Receiver Interface
8. Receiver Indicator Light
9. Receiver Control Buttons

Receiver Usage Instructions

1. Insert the receiver into the mobile phone's port. Once connected, the receiver's light will blink rapidly to indicate that it is properly inserted and ready for use.

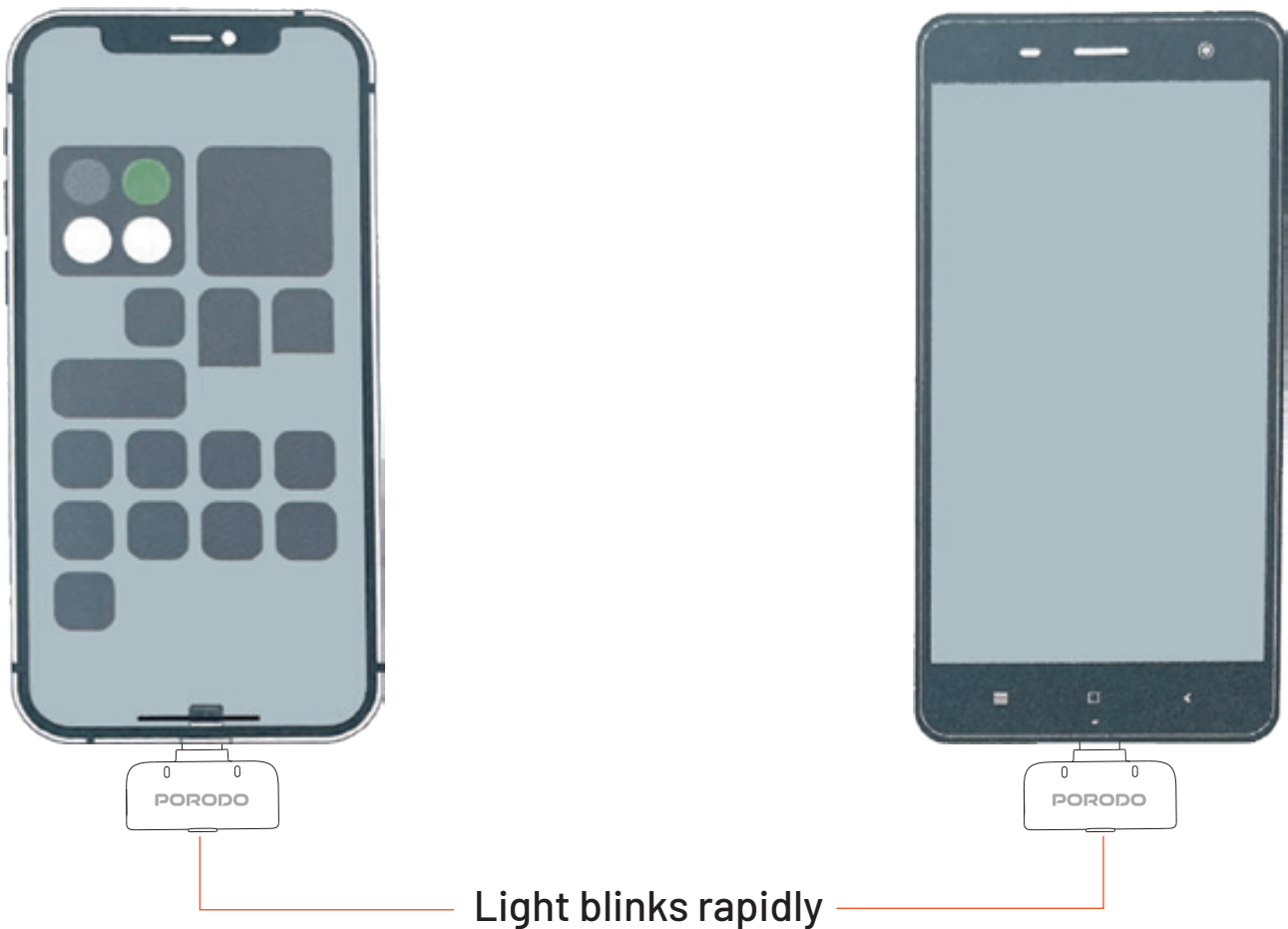

2. Press and hold the power button on the microphone. Once the light indicator turns on, this confirms that the microphone is powered on and ready for use.

Power On/Off

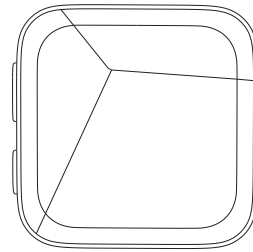

3. Ensure that the indicator light on both the receiver and the microphone is continuously illuminated. This signifies that the connection has been successfully established. Next, open your preferred live video app on your phone. You can now use the microphone to capture and transmit audio during your session.

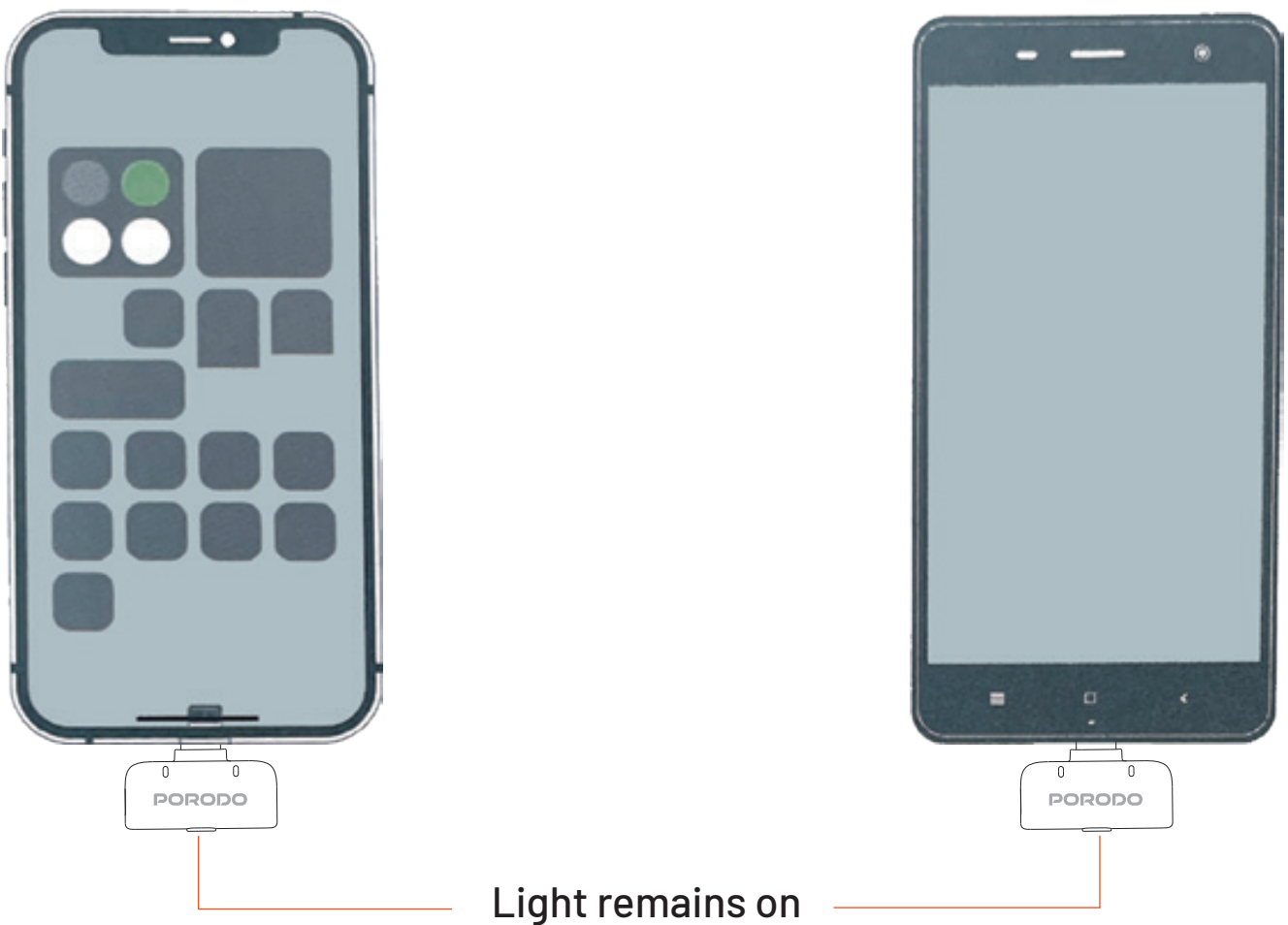

4. If the phone's battery is running low during a live broadcast, the external power supply can directly charge the phone through the receiver's charging port, ensuring uninterrupted performance throughout the broadcast.

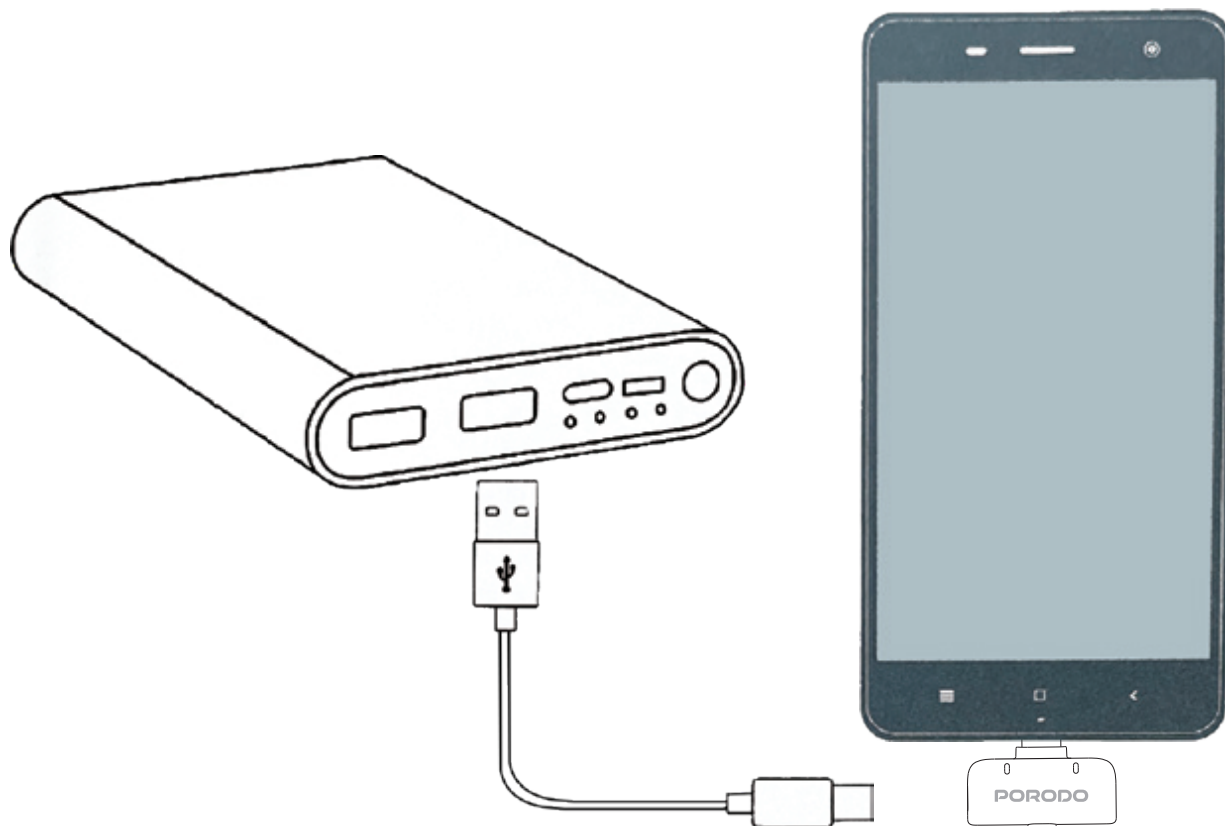

Operation Guide

1. Microphone TX Operation

| Function | Operation Instructions | LED Indicator | Notes |
|----------------------|---|--|--------------------------|
| Power on | Hold the TX power button for 2 seconds. | The connection light flashes slowly | / |
| Power Off | +Hold the TX power button for 3 seconds. | All lights off | / |
| | +Auto-shutdown after 3 minutes if not connected to RZ. | No flashing lights | / |
| Connect to RX | Hold TX for 2 seconds to pair TX and RX when RX is charging on the phone. | After TX and RX are connected, the TX light stays on, and the RX light stays on. | / |
| Disconnect from RX | Power off RX or TX to shut down. | When disconnected, the TX light flashes slowly, and the RX light flashes. | / |
| Power Control Button | Click to mute, click again to unmute. | Light on = mute, Light off = unmute. | / |
| Control Buttons | +Click to turn off noise reduction, click again to turn on. | On = light on, Off = light off (reverb flashing). | Noise reduction: Enabled |
| | +Double-click to turn on mud sound, double-click again to turn off reverberation. | On = Reverb light on, Off = Reverb light off. | Reverb: Off |
| Charging | Plug in a 5V charger. | Light on until full, then turns off | / |

2. Receiver RX Operation

| Function | Operation Instructions | LED Indicator | Notes |
|-----------------------|--|---|----------------------|
| Disconnected | TX and RX automatically pair when RX is plugged into the phone charging port. | RX: Two lights flashing | / |
| Successful Connection | Power on TX, connect RX through the phone charging port. TX and RX automatically pair and connect. | Connect a TX: TX1 stays on, TX2 flashes for 15 seconds, then turns off. Connect 2 TXs: Both lights stay on. | / |
| Key Function | +Press the button to mute/unmute. | +RX: Two lights flash slowly | / |
| | +Double-click to switch between stereo and mono. | +RX: Two lights flash slowly three times | Default mono channel |

Package Contents

1. Microphone transmitter (TX)
2. Receiver (RX)
3. Charging case
4. Type-C charging cable

Safety Precautions

1. Keep the microphone dry and away from moisture or liquid spills. Moisture can damage the microphone and affect performance.
2. Keep the volume at a safe level during use to avoid hearing damage. Start with a lower volume and gradually increase it to your desired level.
3. Do not expose the microphone to high temperatures or direct sunlight for extended periods. Excessive heat can damage the internal components.
4. When using the microphone, ensure it is securely attached to clothing or other stable surfaces to avoid accidental falls or damage.

5. Always unplug the microphone from your device when it is not in use to prevent unnecessary wear and conserve battery life.
6. Store the microphone in a cool, dry place, and use the provided carrying case if available to prevent tangling or damage to the cable.
7. Keep the microphone away from strong magnetic fields, as this can interfere with its functionality and performance.
8. This product is not intended for children. Keep the microphone and all its components out of the reach of children to prevent choking hazards or accidental damage to the device.
9. Never attempt to disassemble, puncture with sharp tools, repair, or modify the microphone. Tampering with the device may result in electrical hazards, malfunction, or permanent damage. Always seek professional assistance for repairs.

Disposal

This product must not be disposed of as unsorted household waste. It is important to separate such waste for proper treatment and recycling, in compliance with local waste management regulations.



Warranty

Products that you buy directly from our **Porodo** website or shop come with a 24-month warranty.

When you buy **Porodo** products from any of our approved sellers, you only get a 12-month warranty. If you want to extend this warranty, go to our website at **porodo.net/warranty** and fill out the form with your information. Don't forget to upload a picture of the product too. After we've checked and accepted your request, we'll send you an email to confirm that your product's warranty has been extended.

For more info, please check:
porodo.net/warranty

Contact Us

If you have any questions about this Privacy Policy, please contact us at:

info@porodo.net

Website: **porodo.net**

Service Support: **support@porodo.net**

Instagram: **porodo**