

**PORODO  
GAMING**



**Porodo Gaming**

**ERGONOMIC**

**RGB Gaming Chair**

SKU: PDXLK2513BK0G

# **Table of Contents**

Product Overview	2
Specifications	2
Product Features	3
Safety Precautions	3
Installation Guide	4
Bluetooth Connection	6
Remote Control Functions	6
FCC Statement	7
Disposal	8
Warranty	9
Contact Us	9

## Product Overview

The Porodo Gaming Ergonomic RGB Gaming Chair combines comfort, innovation, and functionality for an immersive gaming experience. Crafted with an ergonomic comfort design, it ensures proper posture and long-lasting support during intense gaming sessions. The chair features a molded foam seat that contours to your body for superior cushioning and durability, while the adjustable 2D armrests provide personalized positioning for maximum comfort. Dynamic RGB lighting adds a modern, customizable touch, enhancing the overall gaming atmosphere. Built-in speakers further elevate the experience, offering immersive sound directly from the chair. With its premium materials, enhanced comfort, and advanced features, the Porodo Gaming RGB Chair delivers the perfect blend of performance and style for every gamer.

## Specifications

Base	350mm Nylon Base
Wheels	60mm
Back & Seat Material	PVC, Fabric, Mesh
Armrest	2D Armrests with PU Pad
Net Weight	18.5kg
Model Number	PDXLK2513

## Product Features

- 1. Ergonomic Comfort Design:** Built to support your posture during long gaming or working sessions.
- 2. Molded Foam Seat:** High-density foam offers lasting comfort and resilience without losing shape.
- 3. Adjustable 2D Armrests:** Customize height and angle for ideal arm and wrist positioning.
- 4. Dynamic RGB Lighting:** Vibrant lighting effects to match your gaming setup and mood.
- 5. Built-in Speakers:** Enjoy immersive audio directly from the chair for a complete gaming atmosphere.
- 6. Reclining Backrest:** Easily adjust your position for relaxation or focus with smooth tilt control.
- 7. Sturdy Base and Casters:** Durable construction ensures stability and easy movement.
- 8. Enhanced Head and Lumbar Support:** Added cushions provide ergonomic alignment and pressure relief.









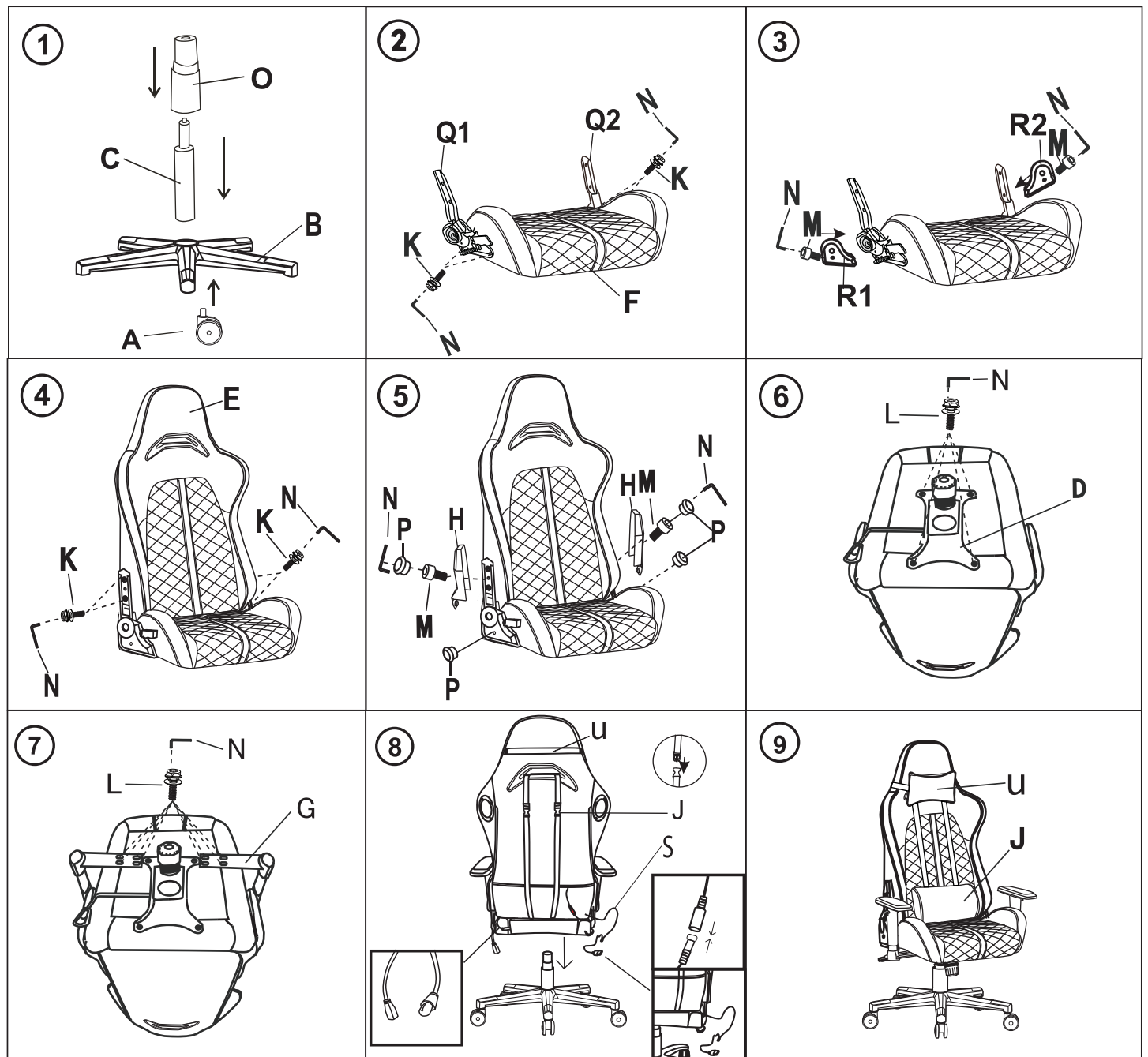



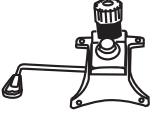
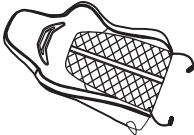

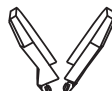

## Safety Precautions

- 1. Ensure all screws and parts are tightly secured before use.**
- 2. Do not exceed the maximum weight capacity specified in the manual.**
- 3. Place the chair on a flat, stable surface to prevent tipping or imbalance.**
- 4. Avoid sitting on the armrests, backrest, or edges of the seat.**
- 5. Keep fingers and hands clear of moving parts during adjustment or assembly.**
- 6. Disconnect the power cable before cleaning or moving the chair.**
- 7. Do not use the RGB lighting or built-in speakers near water or in damp environments.**

8. Keep the chair away from heat sources or direct sunlight for prolonged periods.

## Installation Guide



<b>A</b>		<b>5</b>
<b>B</b>		<b>1</b>
<b>C</b>		<b>1</b>
<b>D</b>		<b>1</b>
<b>E</b>		<b>1</b>
<b>F</b>		<b>1</b>
<b>G</b>		<b>2</b>
<b>H</b>		<b>2</b>
<b>J</b>		<b>1</b>
<b>K</b>	 m30*8mm	<b>8</b>
<b>L</b>	 M25*5mm	<b>12</b>
<b>M</b>	 m8*5mm	<b>4</b>
<b>N</b>		<b>1</b>
<b>O</b>		<b>1</b>
<b>P</b>		<b>4</b>
<b>Q</b>		<b>2</b>
<b>R</b>		<b>2</b>
<b>S</b>		<b>1</b>
<b>T</b>		<b>1</b>
<b>U</b>		<b>1</b>

## Bluetooth Connection

The Porodo Gaming RGB Chair is equipped with Bluetooth connectivity, allowing you to easily connect your devices to the chair's built-in speakers for an immersive audio experience. To establish a Bluetooth connection, follow these simple steps:

- 1.** Turn on Bluetooth: Ensure Bluetooth is enabled on the device you wish to connect to the chair (e.g., PC, smartphone, tablet).
- 2.** Connect to the Chair: On your device, search for available Bluetooth devices and select "Huabox" from the list.
- 3.** Confirmation: Once connected, you will hear a confirmation sound through the chair's built-in speakers.

## Remote Control Functions

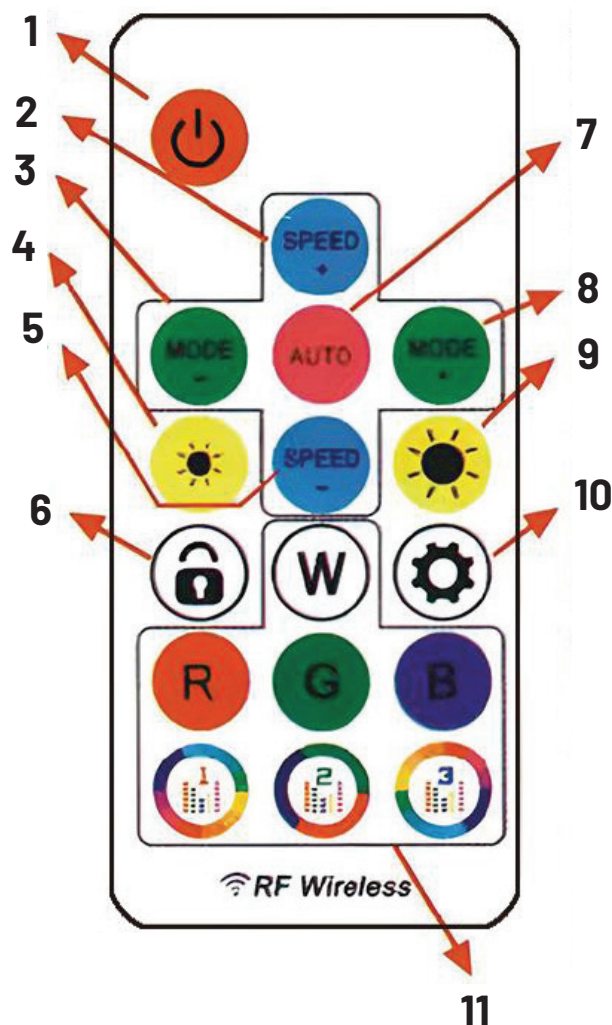

1. Power On/Off
2. Speed +
3. Mode -  
(358 modes)
4. Brightness -  
(Reduce Sensitivity when in music mode)
5. Speed -
6. Remote control ID match: long press 5 seconds to activate remote control one to one match (LED strip green flash 3 times), press it again for 5 seconds to cancel the mach (LED strip white flash 3 times).  
Single cycle play: When in automatic playback mode, press the SET button once, then LOCK button to capture the current effect loop play.
7. Short press AUTO button to play 358 types of effects. Press AUTO 5 times to enter the RGB colorful jump effect to facilitate LED strip test.
8. Mode +  
(358 modes)
9. Brightness +
10. To adjust the number of LED pixel points and the RGB order, press and hold for 5 seconds to enter the setup menu, and press MODE + and MODE - to adjust the number of LED pixel points. Press the RGB button to adjust the RGB order. Press R until the LED strip shows red. Press G until the LED strip shows green, Press B until the LED strip shows blue. when finished, press the SET button to exit.
11. Music mode: There are 12 music modes in total. 4 Modes per key.

## FCC Statement

1. This device complies with Part 15 of the FCC Rules. Operation is subject to the following two conditions:
  - (1) This device may not cause harmful interference; and
  - (2) This device must accept any interference received, including interference that may cause undesired operation.

**2.** Changes or modifications not expressly approved by the party responsible for compliance could void the user's authority to operate the equipment.

**Note:** This equipment has been tested and found to comply with the limits for a Class B digital device, pursuant to Part 15 of the FCC Rules. These limits are designed to provide reasonable protection against harmful interference in a residential installation.

This equipment generates and can radiate radio frequency energy, and if not installed and used in accordance with the instructions, may cause harmful interference to radio communications. However, there is no guarantee that interference will not occur in a particular installation. If this equipment does cause harmful interference to radio or television reception, which can be determined by turning the equipment off and on, the user is encouraged to try to correct the interference by one or more of the following measures:

Reorient or relocate the receiving antenna.

Increase the separation between the equipment and receiver.

Connect the equipment to an outlet on a circuit different from that to which the receiver is connected.

Consult the dealer or an experienced radio/TV technician for assistance.

RF warning statement:

The device has been evaluated to meet general RF exposure requirements. The device can be used in portable exposure conditions without restriction.

## **Disposal**

This product must not be disposed of as unsorted household waste. It is important to separate such waste for proper treatment and recycling, in compliance with local waste management regulations.

## **Warranty**

Products that you buy directly from our **Porodo** website or shop come with a 24-month warranty.

When you buy **Porodo** products from any of our approved sellers, you only get a 12-month warranty. If you want to extend this warranty, go to our website at **porodo.net/warranty** and fill out the form with your information. Don't forget to upload a picture of the product too. After we've checked and accepted your request, we'll send you an email to confirm that your product's warranty has been extended.

For more info, please check:  
**porodo.net/warranty**

## **Contact Us**

If you have any questions about this Privacy Policy, please contact us at:

**info@porodo.net**

Website: **porodo.net**

Service Support: **support@porodo.net**

Instagram: **porodo**